

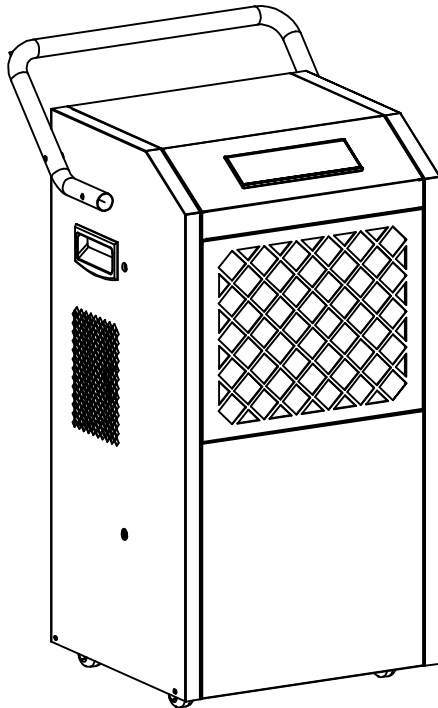

Commercial Dehumidifier User Manual



Please read this user manual before operating and save for future reference.

Model:DE190P

BEFORE FIRST USE:

Please leave the dehumidifier sitting outside the box for **24 HOURS** before plugging it in.

The dehumidifiers may have been tilted or placed upside down during shipping. Leave The dehumidifier sits for 24 hours so the oil in the compressor can settle from the move, Not doing so can affect the performance or lifespan of the dehumidifier.

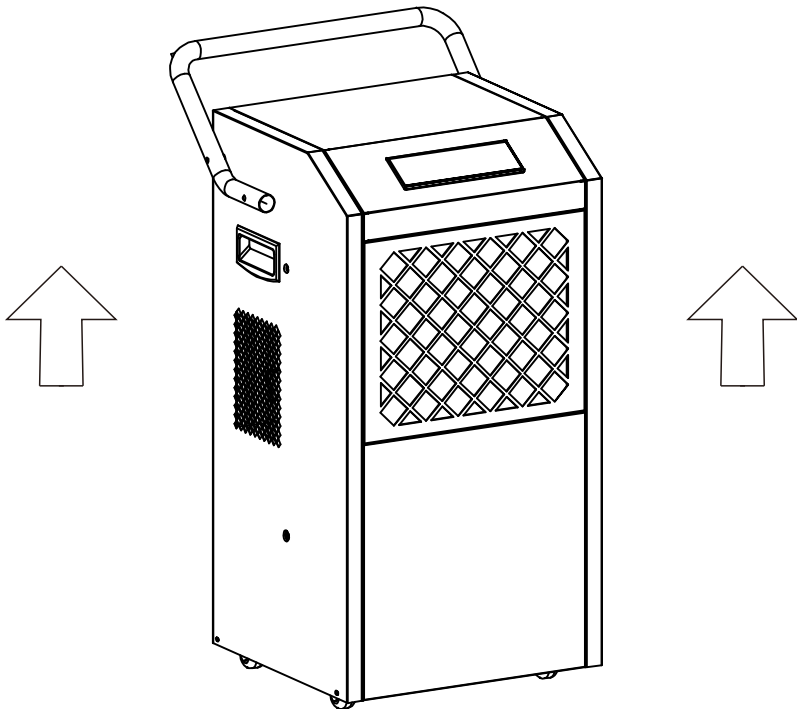

NOTE:

To continuously improve its products, ANDTE reserves the right to modify this information without prior notification. For any questions during assembly, please check the instructions on the product page for reference. Or contact our customer service with any questions, comments, or concerns, We are online 24H for you. Thank you for using ANDTE products in your home!

Welcome

Thanks for choosing **ANDTE** dehumidifier!

ANDTE is dedicated to keeping people healthy, comfortable and more enjoyable by offering quality appliances ranging from dehumidifiers to ice makers, and more. From breathing easier in your office to upgrading your kitchen appliances, we hope **ANDTE** could help you every step of the way.

**READ THIS MANUAL INSTRUCTION CAREFULLY BEFORE USING THE UNIT.
PLEASE KEEP THIS FOR FUTURE REFERENCE.**

ANDTE commercial dehumidifier reducing humidity to comfortable levels in a short period of time. This dehumidifier has a metal housing to withstand harsh environments, is safe and easy to use, guarantees long-term use and easy maintenance. plus we use a copper tube condenser and high quality and accurate sensors, it will be more effective and last longer.

Before plugging in your new dehumidifier, we suggest that you read this user manual as it contains important safety information, operation instructions, troubleshooting, maintenance tips, and warranty information to ensure the reliability and longevity of your dehumidifier.

We're always just an email away

To access customer support, please email to AndteServices@outlook.com with your purchase order.

Thank you again!

Table of Contents

Introduction.....	1
Warning for Using R32 Refrigerant	2
Machine Structure Diagram.....	12
Operation Instruction.....	13
Drain Water.....	16
Maintenance.....	18
Parts List.....	19
Troubleshooting.....	20
Safety Precautions.....	21
Support.....	22

Introduction

Thank you for choosing the dehumidifier by ANDTE!

We hope it will bring great convenience to your work and life.

We recommend that you save the user manual properly for future reference.

Before using this product, please read the user manual carefully to ensure that this product functions at its best.

The ANDTE's dehumidifier adopt an upgraded design, compact structure, easy to operate, and other characteristics, widely used in scientific research, basement, crawl space, greenery, laboratory, gymnasium, sanitation, commodity storage, underground engineering, and dehumidification in high humidity places such as kitchens, bathrooms, archives, warehouses, etc. Can be effectively avoided telecommunications equipment, materials, etc, are damaged due to dampness or rust.

Transportation and Custody

During transportation, this product should be handled preciously to prevent violent vibration. Generally, the packaged product should not be stored in the open air for a long time. It should be placed in a well-ventilated, non-corrosive gas warehouse. It should not be placed upside down. Rainproof measures should be adopted when stored temporarily.

WARNING for Using R32 Refrigerant:

Transportation, marking and storage for units that employ flammable refrigerants

1. General

The following information is provided for units that employ FLAMMABLE REFRIGERANTS.

2. Transport of equipment containing flammable refrigerants

Attention is drawn to the fact that additional transportation regulations may exist with respect to equipment containing flammable gas. The maximum number of pieces of equipment or the configuration of the equipment permitted to be transported together will be determined by the applicable transport regulations.

3. Marking of equipment using signs

Signs for similar appliances used in a work area are generally addressed by local regulations and give the minimum requirements for the provision of safety and/or health signs for a work location. All required signs are to be maintained and employers should ensure that employees receive suitable and sufficient instruction and training on the meaning of appropriate safety signs and the actions that need to be taken in connection with these signs.

The effectiveness of signs should not be diminished by too many signs being placed together. Any pictograms used should be as simple as possible and contain only essential details.

4. Disposal of equipment using flammable refrigerants

See national regulations.

5. Storage of equipment/appliances

The storage of the appliance should be in accordance with the applicable regulations or instructions, whichever is more stringent.

6. Storage of packed (unsold) equipment

Storage package protection should be constructed in such a way that mechanical damage to the equipment inside the package will not cause a leak of the REFRIGERANT CHARGE.

The maximum number of pieces of equipment permitted to be stored together will be determined by local regulations.

Requirements for operation, service and installation manuals of appliances using flammable refrigerants

WARNING

Do not use means to accelerate the defrosting process or to clean, other than those recommended by the manufacturer.

The appliance shall be stored in a room without continuously operating ignition sources (for example: open flames, an operating gas appliance or an operating electric heater. Do not pierce or burn.

Be aware that refrigerants may not contain an odour.

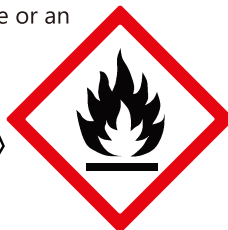

Refrigerant
Safety Group
A2L

Qualification of workers

The manual shall contain specific information about the required qualification of the working personnel for maintenance, service and repair operations. Every working procedure that affects safety means shall only be carried out by competent persons.

Examples for such working procedures are:

- breaking into the refrigerating circuit;
- opening of sealed components;

Competence of service personnel

1. General

Information of procedures additional to usual information for refrigerating appliance installation, repair, maintenance and decommission procedures is required when an appliance with FLAMMABLE REFRIGERANT is affected.

The training of these procedures is carried out by national training organisations or manufacturers that are accredited to teach the relevant national competency standards that may be set in legislation.

The achieved competence should be documented by a certificate.

2. Information and training

2.1) The training should include the substance of the following.

2.2) Information about the explosion potential of FLAMMABLE REFRIGERANTS to show that flammables may be dangerous when handled without care.

2.3) Information about POTENTIAL IGNITION SOURCES, especially those that are not obvious, such as lighters, light switches, vacuum cleaners, electric heaters.

2.4) Information about the different safety concepts:

- Unventilated-Safety of the appliance does not depend on ventilation of the housing.
- Switching off the appliance or opening of the housing has no significant effect on the safety.
- Nevertheless, it is possible that leaking refrigerant may accumulate inside the enclosure and flammable atmosphere will be released when the enclosure is opened.
- Ventilated enclosure-Safety of the appliance depends on ventilation of the housing.
- Switching off the appliance or opening of the enclosure has a significant effect on the safety.
- Care should be taken to ensure sufficient ventilation before.
- Ventilated room -Safety of the appliance depends on the ventilation of the room.
- Switching off the appliance or opening of the housing has no significant effect on the safety.
- The ventilation of the room shall not be switched off during repair procedures.

2.5) Information about refrigerant detectors:

- Principle of function, including influences on the operation.
- Procedures, how to repair, check or replace a refrigerant detector or parts of it in a safe way.
- Procedures, how to disable a refrigerant detector in case of repair work on the refrigerant carrying parts.

2.6) Information about the concept of sealed components and sealed enclosures according to IEC60079-15:2010.

2.7) Information about the correct working procedures:

a) Commissioning

- Ensure that the floor area is sufficient for the REFRIGERANT CHARGE or that the ventilation duct is assembled in a correct manner.
- Connect the pipes and carry out a leak test before charging with refrigerant.
- Check safety equipment before putting into service.

b) Maintenance

- Portable equipment shall be repaired outside or in a workshop specially equipped for servicing units with FLAMMABLE REFRIGERANTS.
- Ensure sufficient ventilation at the repair place.
- Be aware that malfunction of the equipment may be caused by refrigerant loss and a refrigerant leak is possible.
- Discharge capacitors in a way that won't cause any spark. The standard procedure to short circuit the capacitor terminals usually creates sparks.
- Reassemble sealed enclosures accurately. If seals are worn, replace them.
- Check safety equipment before putting into service.

c) Repair

- Portable equipment shall be repaired outside or in a workshop specially equipped for servicing units with FLAMMABLE REFRIGERANTS.
- Ensure sufficient ventilation at the repair place.
- Be aware that malfunction of the equipment may be caused by refrigerant loss and a refrigerant leak is possible.
- Discharge capacitors in a way that won't cause any spark.
- When brazing is required, the following procedures shall be carried out in the following order:
--Safely remove the refrigerant following local and national regulations. If the recovery is not required by national regulations, drain the refrigerant to the outside. Take care that the drained refrigerant will not cause any danger. In doubt, one person should guard the outlet. Take special care that drained refrigerant will not float back into the building;

d) Decommissioning

- If the safety is affected when the equipment is putted out of service, the REFRIGERANT CHARGE shall be removed before decommissioning.
- Ensure sufficient ventilation at the equipment location.
- Be aware that malfunction of the equipment may be caused by refrigerant loss and a refrigerant leak is possible.
- Discharge capacitors in a way that won't cause any spark.
- Remove the refrigerant. If the recovery is not required by national regulations, drain the refrigerant to the outside. Take care that the drained refrigerant will not cause any danger. In doubt,one person should guard the outlet. Take special care that drained refrigerant will not float back into the building.
- When FLAMMABLE REFRIGERANTS except A2L REFRIGERANTS are used,

-
- Evacuate the refrigerant circuit.
 - Purge the refrigerant circuit with nitrogen for 5 min.
 - Evacuate again.
 - Fill with nitrogen up to atmospheric pressure.
 - Put a label on the equipment that the refrigerant is removed.

e) Disposal

- Ensure sufficient ventilation at the working place.
- Remove the refrigerant. If the recovery is not required by national regulations, drain the refrigerant to the outside. Take care that the drained refrigerant will not cause any danger. In doubt, one person should guard the outlet. Take special care that drained refrigerant will not float back into the building.
- When flammable refrigerants are used,
 - evacuate the refrigerant circuit.
 - purge the refrigerant circuit with oxygen free nitrogen.
 - evacuate again. (not required for A2L refrigerants); and
 - cut out the compressor and drain the oil.

Information on servicing

1. General

The manual shall contain specific information for service personnel according.

2. Checks to the area

Prior to beginning work on systems containing FLAMMABLE REFRIGERANTS, safety checks are necessary to ensure that the risk of ignition is minimised. For repair to the REFRIGERATING SYSTEM

3. Work procedure

Work shall be undertaken under a controlled procedure so as to minimise the risk of a flammable gas or vapour being present while the work is being performed.

4. General work area

All maintenance staff and others working in the local area shall be instructed on the nature of work being carried out. Work in confined spaces shall be avoided.

5. Checking for presence of refrigerant

The area shall be checked with an appropriate refrigerant detector prior to and during work, to ensure the technician is aware of potentially toxic or flammable atmospheres. Ensure that the leak detection equipment being used is suitable for use with all applicable refrigerants, i. e. non-sparking, adequately sealed or intrinsically safe.

6. Presence of fire extinguisher

If any hot work is to be conducted on the refrigerating equipment or any associated parts, appropriate fire extinguishing equipment shall be available to hand. Have a dry powder or CO2 fire extinguisher adjacent to the charging area.

7. No ignition sources

No person carrying out work in relation to a REFRIGERATING SYSTEM which involves exposing any pipe work shall use any sources of ignition in such a manner that it may lead to the risk of fire or explosion. All possible ignition sources, including cigarette smoking, should be kept sufficiently far away from the site of installation, repairing, removing and disposal, during which refrigerant can possibly be released to the surrounding space. Prior to work taking place, the area around the equipment is to be surveyed to make sure that there are no flammable hazards or ignition risks. "No Smoking" signs shall be displayed.

8. Ventilated area

Ensure that the area is in the open or that it is adequately ventilated before breaking into the system or conducting any hot work. A degree of ventilation shall continue during the period that the work is carried out. The ventilation should safely disperse any released refrigerant and preferably expel it externally into the atmosphere.

9. Checks to the refrigerating equipment

Where electrical components are being changed, they shall be fit for the purpose and to the correct specification. At all times the manufacturer's maintenance and service guidelines shall be followed. If in doubt, consult the manufacturer's technical department for assistance. The following checks shall be applied to installations using.

FLAMMABLE REFRIGERANTS:

- the actual REFRIGERANT CHARGE is in accordance with the room size within which the refrigerant containing parts are installed;
- the ventilation machinery and outlets are operating adequately and are not obstructed;
- if an indirect refrigerating circuit is being used, the secondary circuit shall be checked for the presence of refrigerant;
- marking to the equipment continues to be visible and legible. Markings and signs that are illegible shall be corrected;
- refrigerating pipe or components are installed in a position where they are unlikely to be exposed to any substance which may corrode refrigerant containing components, unless the components are constructed of materials which are inherently resistant to being corroded or are suitably protected against being so corroded.

10. Checks to electrical devices

Repair and maintenance to electrical components shall include initial safety checks and component inspection procedures. If a fault exists that could compromise safety, then no electrical supply shall be connected to the circuit until it is satisfactorily dealt with. If the fault cannot be corrected immediately but it is necessary to continue operation, an adequate temporary solution shall be used. This shall be reported to the owner of the equipment so all parties are advised.

Initial safety checks shall include:

- that capacitors are discharged: this shall be done in a safe manner to avoid possibility of sparking;
- that no live electrical components and wiring are exposed while charging, recovering or purging the system;
- that there is continuity of earth bonding.

11. Repairs to sealed components

1) During repairs to sealed components, all electrical supplies shall be disconnected from the equipment being worked upon prior to any removal of sealed covers, etc. If it is absolutely necessary to have an electrical supply to equipment during servicing, then a permanently operating form of leak detection shall be located at the most critical point to warn of a potentially hazardous situation.

2) Sealed electrical components shall be replaced.

12. Repair to intrinsically safe components

Do not apply any permanent inductive or capacitance loads to the circuit without ensuring that this will not exceed the permissible voltage and current permitted for the equipment in use. Intrinsically safe components must be replaced.

Replace components only with parts specified by the manufacturer. Other parts may result in the ignition of refrigerant in the atmosphere from a leak.

13. Cabling

Check that cabling will not be subject to wear, corrosion, excessive pressure, vibration, sharp edges or any other adverse environmental effects. The check shall also take into account the effects of aging or continual vibration from sources such as compressors or fans.

14. Detection of flammable refrigerants

Under no circumstances shall potential sources of ignition be used in the searching for or detection of refrigerant leaks. A halide torch (or any other detector using a naked flame) shall not be used. The following leak detection methods are deemed acceptable for all refrigerant systems.

Electronic leak detectors may be used to detect refrigerant leaks but, in the case of FLAMMABLE REFRIGERANTS, the sensitivity may not be adequate, or may need re-calibration. (Detection equipment shall be calibrated in a refrigerant-free area.)

Ensure that the detector is not a potential source of ignition and is suitable for the refrigerant used. Leak detection equipment shall be set at a percentage of the LFL of the refrigerant and shall be calibrated to the refrigerant employed, and the appropriate percentage of gas (25 % maximum) is confirmed.

Leak detection fluids are also suitable for use with most refrigerants but the use of detergents containing chlorine shall be avoided as the chlorine may react with the refrigerant and corrode the copper pipe-work.

If a leak is suspected, all naked flames shall be removed/extinguished.

If a leakage of refrigerant is found which requires brazing, all of the refrigerant shall be recovered from the system, or isolated (by means of shut off valves) in a part of the system remote from the leak. Removal of refrigerant shall be according to Removal and evacuation.

15. Removal and evacuation

When breaking into the refrigerant circuit to make repairs -or for any other purpose-conventional procedures shall be used. However, for flammable refrigerants it is important that best practice be followed, since flammability is a consideration.

The following procedure shall be adhered to:

- safely remove refrigerant following local and national regulations;
- purge the circuit with inert gas(optional for A2L);
- evacuate(optional for A2L);
- continuously flush or purge with inert gas when using flame to open circuit ;and
- open the circuit .

The refrigerant charge shall be recovered into the correct recovery cylinders if venting is not allowed by local and national codes. For appliances containing flammable refrigerants, the system shall be purged with oxygen-free nitrogen to render the appliance safe for flammable refrigerants. This process might need to be repeated several times. Compressed air or oxygen shall not be used for purging refrigerant systems.

For appliances containing flammable refrigerants, refrigerants purging shall be achieved by breaking the vacuum in the system with oxygen-free nitrogen and continuing to fill until the working pressure is achieved, then venting to atmosphere, and finally pulling down to a vacuum (optional for A2L). This process shall be repeated until no refrigerant is within the system (optional for A2L). When the final oxygen-free nitrogen charge is used, the system. The outlet for the vacuum pump shall not be close to any potential ignition sources, and ventilation shall be available.

16. Charging procedures

In addition to conventional charging procedures, the following requirements shall be followed.

- Ensure that contamination of different refrigerants does not occur when using charging equipment. Hoses or lines shall be as short as possible to minimise the amount of refrigerant contained in them.
- Cylinders shall be kept in an appropriate position according to the instructions.
- Ensure that the REFRIGERATING SYSTEM is earthed prior to charging the system with refrigerant.
- Label the system when charging is complete (if not already).
- Extreme care shall be taken not to overfill the REFRIGERATING SYSTEM. Prior to recharging the system, it shall be pressure-tested with the appropriate purging gas. The system shall be leak-tested on completion of charging but prior to commissioning. A follow up leak test shall be carried out prior to leaving the site.

17. Decommissioning

Before carrying out this procedure, it is essential that the technician is completely familiar with the equipment and all its detail. It is recommended good practice that all refrigerants are recovered safely. Prior to the task being carried out, an oil and refrigerant sample shall be taken in case analysis is required prior to re-use of recovered refrigerant. It is essential that electrical power is available before the task is commenced.

-
- a) Become familiar with the equipment and its operation.
 - b) Isolate system electrically.
 - c) Before attempting the procedure, ensure that:
 - Mechanical handling equipment is available, if required, for handling refrigerant cylinders;
 - All personal protective equipment is available and being used correctly;
 - The recovery process is supervised at all times by a competent person;
 - Recovery equipment and cylinders conform to the appropriate standards.
 - d) Pump down refrigerant system, if possible.
 - e) If a vacuum is not possible, make a manifold so that refrigerant can be removed from various parts of the system.
 - f) Make sure that cylinder is situated on the scales before recovery takes place.
 - g) Start the recovery machine and operate in accordance with instructions.
 - h) Do not overfill cylinders (no more than 80 % volume liquid charge).
 - i) Do not exceed the maximum working pressure of the cylinder, even temporarily.
 - j) When the cylinders have been filled correctly and the process completed, make sure that the cylinders and the equipment are removed from site promptly and all isolation valves on the equipment are closed off.
 - k) Recovered refrigerant shall not be charged into another REFRIGERATING SYSTEM unless it has been cleaned and checked.

18. Labelling

Equipment shall be labelled stating that it has been de-commissioned and emptied of refrigerant. The label shall be dated and signed. For appliances containing FLAMMABLE REFRIGERANTS, ensure that there are labels on the equipment stating the equipment contains FLAMMABLE REFRIGERANT.

19. Recovery

When removing refrigerant from a system, either for servicing or decommissioning, it is recommended good practice that all refrigerants are removed safely. When transferring refrigerant into cylinders, ensure that only appropriate refrigerant recovery cylinders are employed. Ensure that the correct number of cylinders for holding the total system charge is available. All cylinders to be used are designated for the recovered refrigerant and labelled for that refrigerant (i. e. special cylinders for the recovery of refrigerant). Cylinders shall be complete with pressure-relief valve and associated shut-off valves in good working order. Empty recovery cylinders are evacuated and, if possible, cooled before recovery occurs.

The recovery equipment shall be in good working order with a set of instructions concerning the equipment that is at hand and shall be suitable for the recovery of the flammable refrigerant. If in doubt, the manufacturer should be consulted. In addition, a set of calibrated weighing scales shall be available and in good working order. Hoses shall be complete with leak-free disconnect couplings and in good condition.

The recovered refrigerant shall be processed according to local legislation in the correct recovery cylinder, and the relevant waste transfer note arranged. Do not mix refrigerants in recovery units and especially not in cylinders.

If compressors or compressor oils are to be removed, ensure that they have been evacuated to an acceptable level to make certain that flammable refrigerant does not remain within the lubricant. The compressor body shall not be heated by an open flame or other ignition sources to accelerate this process. When oil is drained from a system, it shall be carried out safely.

General Safety Instruction

1. The appliance is for indoor use only.
2. Do not use the unit on a socket under repairs or not installed properly
3. Do not use the unit, follow these precautions:
 - A: Near to source of fire.
 - B: An area where oil is likely to splash.
 - C: An area exposed to direct sunlight.
 - D: An area where water is likely to splash.
4. All the sockets must comply with the local electric safety requirements. If necessary, please check it for the requirements.
5. Children should be supervised to ensure that they do not play with the appliance.
6. If the supply cord is damaged, it must be replaced by the manufacturer, its service agent or similarly qualified persons in order to avoid a hazard.
7. Children should be supervised to ensure that they do not play with the appliance.
8. This appliance is not intended for use by persons (including children) with reduced physical, sensory or mental capabilities, or lack of experience and knowledge, unless they have been given supervision or instruction concerning use of the appliance by a person responsible for their safety.
9. That the appliance shall be installed in accordance with national wiring regulations.
10. The applicable operating temperature range for this unit is 41°F -95°F ;
Model Specifications for Fuse : 3.15A,250VAC;

Recycling

This marking indicates that this product should not be disposed with other household wastes. To prevent possible harm to the environment or human health from uncontrolled waste disposal recycle it responsibly to promote the sustainable reuse of material resources. To return your used device, please use the return and collection systems or contact the retailer where the product was purchased. They can take this product for environmental safe recycling.



11. Contact authorized service technician for repair or maintenance of this unit.
12. Do not pull deform. or modify the power supply cord, or immerse it in water. Pulling or misuse of the power supply cord can result in damage to the unit and cause electrical shock.

-
13. Compliance with national gas regulations shall be observed.
 14. Keep ventilation openings clear of obstruction.
 15. Any person who is involved with working on or breaking into a refrigerant circuit should hold a current valid certificate from an industry-accredited assessment authority, which authorizes their competence to handle refrigerants safely in accordance with an industry recognized assessment specification.
 16. Servicing shall only be performed as recommended by the equipment manufacturer. Maintenance and repair requiring the assistance of other skilled personnel shall be carried out under the supervision of the person competent in the use of flammable refrigerants.
 17. Do not operate or stop the unit by inserting or pulling out Die power plug, it may cause electric shock or fire due to heat generation.
 18. Unplug the unit if strange sounds, smell, or smoke comes from it.
 19. Install the dehumidifier on flat surface to minimize vibration and or noise.
 20. Inspect the power cord before use. Never operate the dehumidifier when the power cord or plug is damaged.
 21. Insert the three-prong plug on the power cord into a matching electrically grounded outlet.
 22. Do not use an adapter. Never cut off the third prong. Do not use an extension cord.
 23. Do not operate the dehumidifier in standing water. Keep motor and wiring dry.
 24. Never immerse the dehumidifier into water or other liquids.
 25. Do not put the dehumidifier close to heat-generating devices, including flammable or dangerous materials.
 26. Unplug the power supply before cleaning or storing the dehumidifier. Always grasp the plug (not the cord) to unplug.
 27. Do not put fingers or other items into air inlet or air outlet.
 28. Never insert any other objects into the dehumidifier body.
 29. Do not sit, stand or put heavy objects on the dehumidifier.

-If any parts damage, please contact the dealer or a designated repair shop;

-In case of any damage, please turn off the air switch, disconnect the power supply, and contact the dealer or a designated repair shop;

-In any case, the power cord shall be firmly grounded.

-To avoid the possibility of danger, if power cord is damaged, please turn off the air switch and disconnect the power supply. It must be replaced from the dealer or a designated repair shop.



Never repair or remove plug and or power cord. Any repairs should be completed by qualified electrician or distributor.

Machine Structure Diagram

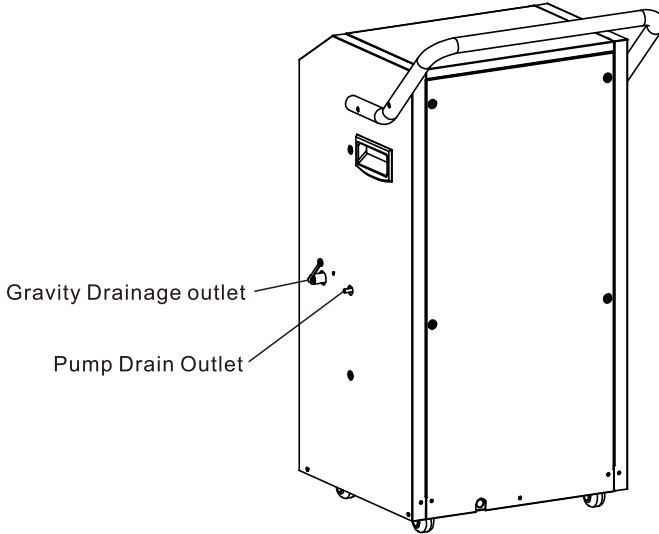
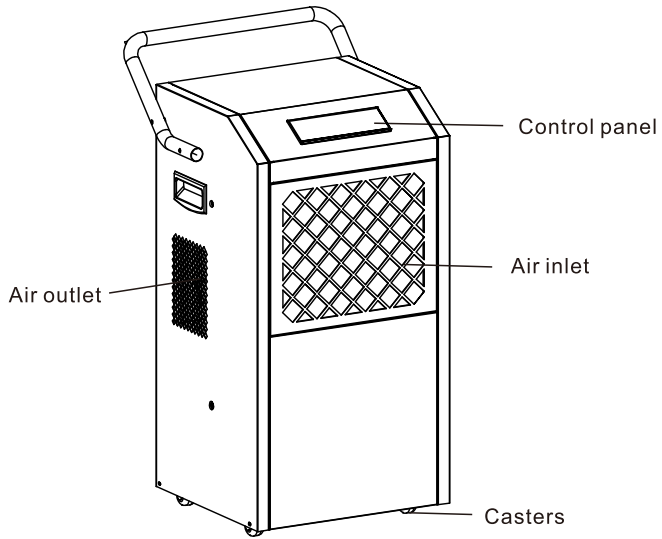

NOTE: There May be slight differences in the model, the actual machine shall prevail.

Operation Instruction

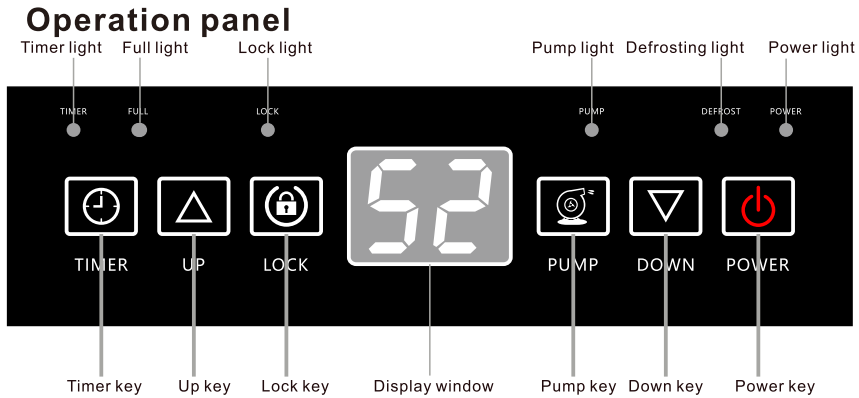

Key description:

1. Power switch key: In the shutdown state, press once to turn on the machine, otherwise turn off the machine.
2. Up key: Increase the humidity setting value.
3. Down key: decrease the humidity setting value.
4. Timer key: used to set the timing time.

Humidity setting:

In the power-on state, press the "Up" or "Down" key once to enter the humidity setting state: the display screen flashes the humidity setting value "** *". In the humidity setting state, press the "Up" or "Down" key to set the humidity, and the setting range is 10-98% RH. After the key operation is stopped for a few seconds, the humidity setting state is automatically exited.

Timer setting:

Timed startup: When the set timing time is reached, the dehumidifier automatically starts, and the time range can be set to be 0-24 hours.

Timed shutdown: When the set timing time is reached, the dehumidifier automatically shuts down, and the time range can be set to be 0-24 hours.

Set time to turn on (OFF)

1. When the dehumidifier is in the dehumidifier state, press the "Timing" key, the timing indicator is on, and the dehumidifier enters the timing startup setting state; When the dehumidifier is on, press the "Timing" key, the timing indicator is on, and the dehumidifier enters the setting state of timing shutdown.
2. In the setting state of scheduled startup or scheduled shutdown, press "Timing" to set the timing time, 5 seconds later, the display area of the dehumidifier control board restores the humidity display, and the timing setting is complete.

Example Query the remaining periodic time

Press "Timing". The time displayed in the display area of the dehumidifier control panel is the remaining reservation time. The original status will be displayed 5 seconds later.

Untiming

Press "Timing" key to enter the setting state of timing startup (shutdown), press "timing" key to adjust the time to 0 to cancel the setting of timing Settings, timing indicator off.

Change timing

If you need to change the timing time, reset the timing time.

LOCK Setting:

To lock/unlock the Control Panel.

Press and hold the LOCK button for 3-5 seconds to lock or unlock the control panel. When the LOCK function has been activated, the indicator illuminates, and other buttons will be disabled. To regain use of the buttons, unlock the control button.

PUMP Button

Used to start the water pump.

Drainage

During operation, the pump will automatically pump the condensation out via the drain hose when the pump reservoir is full. No manual intervention! Before moving the dehumidifier, press and hold the PUMP button for 3-5 seconds to empty the pump reservoir to avoid water spillage. The PUMP indicator will light up when the pump is working. The pump will stop working automatically and the PUMP light will go off when the pump reservoir is almost empty.

Action description:

Startup: the fan is turned on, and the compressor 1 is turned on with a delay of several seconds.

Shutdown: the compressor is stopped immediately, and the fan is stopped after a delay of several seconds.

Without turning on the power supply, the compressor can be turned on again after it stops running for 3 minutes.

Defrosting function:

When operating at low ambient temperature, the system will automatically judge whether there is frost, and if there is frost, it will automatically defrost.

Defrosting action: the fan does not stop and the compressor stops.

End of defrosting: the defrosting indicator is off, and the fan and compressor operate according to the humidity control requirements.

Defrost display: when defrosting, the defrosting indicator is on.

Fault Code

S/N	Error Code	Causes	Solutions
1	Ēc (Ec) (Control Panel Communication Failure)	1. Faulty Main Control Board. 2. Faulty Display Panel. 3. Faulty Connection Cables.	1. Replace the main control board. 2. Replace the display panel. 3. Replace communication cables.

(Whether the above fault codes exist depends on whether the actual model has this function.)

Notice:

1. EC fails, operation of the machine is not controlled by the buttons on the operation panel. Please check whether the connection wire between the display board and the main control board is loose or poor contact caused by other reasons. If it is caused by looseness, please re-tighten it. If it is caused by loose wire terminals or broken wires, please contact a professional for repair.
2. When the "  FULL " is on, Machine will stop working. Please contact a professional to deal with it. If you need to use the machine immediately, please open the electric control box, pull out the plug on the "WF" position of the main control board, and open the natural drainage port to connect the water pipe to power on.

*** Dealing with the above problems requires power off.**

State Description

- 1)**Power On:** The fan starts running, and the compressor starts to run after a delay of a few seconds.
- 2)**Power Off:** The compressor stops running immediately, and the fan stops after a few seconds delay.
- 3)To prevent the machine from starting and stopping frequently, there is a 3-minute delay in the start-up interval.

Turn The Dehumidifier Off

Press the Power Switch to turn the dehumidifier off.

Note: To protect the compressor, the fan will continue to operate for 5 seconds after the dehumidifier has shut off. So please do not disconnect the power cord to force the dehumidifier to stop. Always use the power button.

Drain Water

1. Drain by Internal Pump

The dehumidifier has an internal pump that helps to drain the condensation water freely.

When using the pump feature.

- The Gravity Drain Outlet needs to be sealed by the included stopper;
- Connect the drain hose to the Pump Drain Outlet;
- Place the unattached end of the hose in a sink, bucket, pump sump, or out of a window anywhere that water can drain out safely. (Ensure there are no kinks or other obstructions that will stop the water to flow.)

NOTE:

- If you use a bucket or other container for water collection, check it regularly to prevent overflows.
- The drain hose for the water pump can drain vertically up to 16ft. More than 16ft may cause water back up to the pump resulting in leakage.
- If the drain hose is too long, water may not drain completely, which can lead to stagnant water and mildew build up inside the hose.
- Before moving the dehumidifier, please remove the stopper from the Gravity Drain Outlet to completely drain the condensation in the internal water tray to avoid water leakage.

2. Drain by Gravity

The collected condensation water can be drained by gravity. When using gravity to drain.

- Connect the drain hose to the Gravity Drain Outlet;
- Place the unattached end of the hose to a suitable drainage facility. The drainage facility should be lower than the drain outlet of the dehumidifier. (Ensure there are no kinks or other obstructions that will stop the water to flow.)

Picture 1: Example of improper installation.

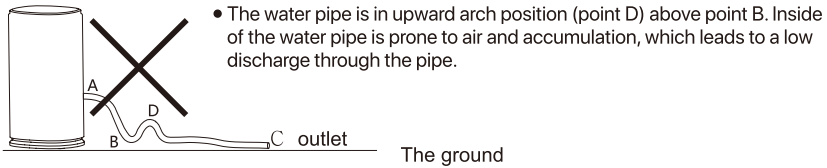

Picture 2: Example of improper installation.

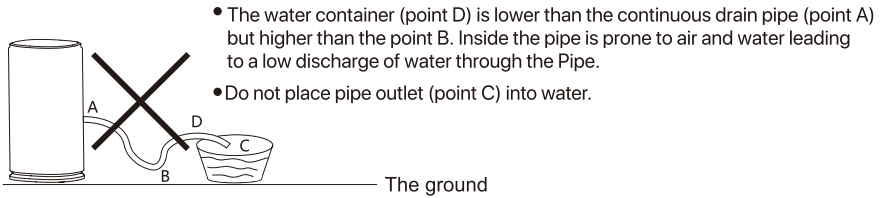

Picture 3: Example of proper installation.

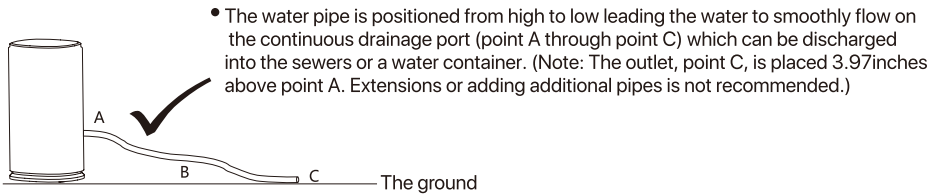

The picture is for reference only.

Maintenance

Unplug the power cord before maintaining and cleaning the dehumidifier. Use a soft damp cloth to clean the body of the dehumidifier. Don't use detergents, scrubbing wires, chemically treated dusting cloths, gasoline, thinner, or other solvents to clean and wipe the machine.

Clean the filter:

There is a washable filter behind the dehumidifier to filter airborne dirt. It is recommended to check the filter regularly and clean it at least once a month.







- 1) Use a vacuum cleaner or something to gently remove the dirt on the filter;
- 2) If the filter is particularly dirty, rinse it with warm water and mild detergent, and dry it thoroughly; do not expose the filter to direct sunlight or use other exothermic products to dry the filter, which will deform the filter and its frame;
- 3) Put the dried filter back into the dehumidifier; If the dehumidifier fails, please follow the "Troubleshooting" in the manual before contacting ANDTE support. Do not repair or disassemble the dehumidifier by yourself.

Improper maintenance may endanger the safety of users.

Note: Don't operate the dehumidifier without a filter because dirt and lint may clog it.

Parts List

1. Parts list:

Picture	Name	Quantity
	Gravity Drain hose	1PCS
	Drainpipes Fastening Rings	1PCS
	Pump Drain hose	1PCS
	Rubber Stopper	1PCS
	Handle	1PCS
	Machine tooth screws with rubber head	4PCS

Troubleshooting

Before seeking support from the service team, you can check the following troubleshooting tips:

Fault	Cause	Solution
Dehumidifier not working	<ol style="list-style-type: none"> 1.The fuse is blown 2.Machine failure prompt 	<ol style="list-style-type: none"> 1.Replace the fuse; 2.Please provide the fault code and seek technical support from ANDTE;
Dehumidifying effect is not obvious	<ol style="list-style-type: none"> 1.Air filter fouling; 2.There are obstacles in the air inlet and outlet of the dehumidifier; 3.The space is not sealed; 4.Refrigerant leakage; 	<ol style="list-style-type: none"> 1.Clean the filter; 2.Remove obstacles; 3.Close the doors and windows, the dehumidification effect of the confined space is more obvious; 4.Please contact ANDTE for technical support;
Water leakage	<ol style="list-style-type: none"> 1.Machine tilt; 2.The outlet pipe is Blocked; 	<ol style="list-style-type: none"> 1.Adjust the machine and place it horizontally; 2.Remove the access door to remove the foreign matter blocked in the pipe;
Abnormal noise	<ol style="list-style-type: none"> 1.The machine is not placed smoothly; 2.Is the filter blocked; 	<ol style="list-style-type: none"> 1.Relocate the machine to a stable place; 2.Clean the filter;
Humidity always shows "10"(when there is a big difference from the actual humidity)	Humidity sensor failure	<ol style="list-style-type: none"> 1.When the "10" fault phenomenon is always displayed, the humidity is set to 10%RH, and the machine can still continue to run and be used normally; 2.Repair and replace the humidity sensor;
Humidity always shows "99"(when there is a big difference from the actual humidity)	<ol style="list-style-type: none"> 1.The surface of the humidity sensor os condensed or wetted with water; 2.Humidity sensor failure 	<ol style="list-style-type: none"> 1.When the "99" fault phenomenon is displayed all the time, the machine can still continue to dehumidify and operate normally; 2.After the machine has been running for a period of time, when the moisture on the surface of the humidity sensor dissipates,ig can automatically remove the fault and resume normal operation; 3.Repair and replace the humidity sensor;

1. When the above fault cannot be eliminated and it is confirmed that repair is required, please contact the ANDTE support, please do not disassemble the machine for repair without authorization.
2. When the dehumidifier is running or stopped, it is normal to hear the sound of refrigerant circulating.
3. It is normal for hot air to be discharged from the air outlet.

Safety Precautions



1. When using, do not place the dehumidifier on soft, uneven ground to avoid vibration or movement.

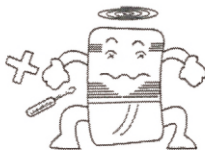

2. Do not use thin rods or hard objects to insert into the fuselage to avoid malfunction or danger.

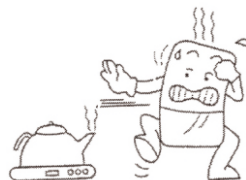

3. When using, please keep the dehumidifier away from heat sources such as heaters and electric kettles to save electricity.



4. When using, please close the doors and windows to achieve the best dehumidification effect.



5. Do not place items before and after the dehumidifier. If the ventilation is blocked, the dehumidification effect will be affected.



6. In case of power failure or long-term non-use, please unplug the power cord.



7. When cleaning the dehumidifier, gently wipe it with a damp cloth, do not directly spray water to clean it.

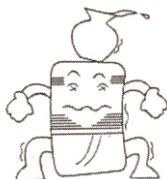

8. Do not place any objects on the dehumidifier.



9. Please clean the filter every two weeks (do not use hot water above 104°F/40°C, alcohol, gasoline, or toluene).



10. During continuous drainage, the drainage pipe must be placed horizontally or downwards, and must not be uneven or entangled.



11. After the filter is cleaned, please do not place it in direct sunlight to dry it to avoid deformation.



12. Before moving or carrying the dehumidifier, please pour out the accumulated water in the water tank.

Warranty and Service

If you have an issue with an ANDTE product, please contact us at AndteServices@outlook.com, and we will do our best to resolve it for you.



Support Hours

24 Hours available

*Please have your order number before contacting customer support.

Product Certification

The product is approved to leave the factory after passing the inspection.

Production date: see the nameplate or barcode of the fuselage





ANDTE

