

Glowells

Model:PD12A

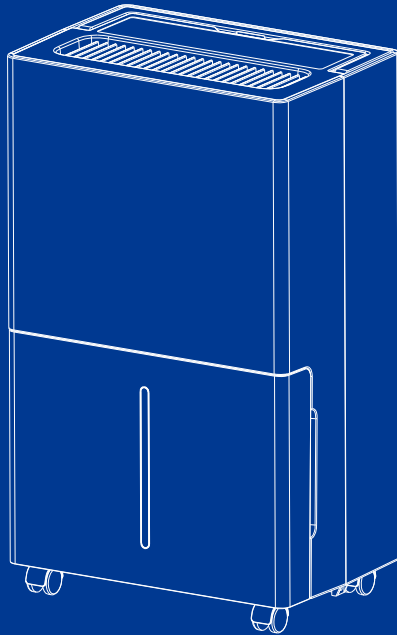

Thank you for your order.
You made our day.

Thanks for your purchase.
If any problems with our dehumidifier, please feel free to contact us

Please refer to the model on the nameplate of the machine.
Please read the user manual carefully before use and keep it properly.

[Email:support@glowellshop.com](mailto:support@glowellshop.com)

Instructions for Use:

1. **Dehumidification Capacity**-The dehumidification capacity of dehumidifier is related to the area used and the ambient temperature and humidity, and the water tank capacity is not equal to the dehumidification capacity.

2. Control Panel Flashing: Dehumidifier will turn into stand by mode and flashing when the current humidity level lower than setting level, please try to set a lower target level or wait for the current humidity level rise and higher than the setting level, it will start running again from stand by mode.

If the humidity of the dehumidifier is inconsistent with the humidity you measured, it is mainly due to the inconsistency of the measurement location or the inconsistency of the evaluation method of the hygrometer and the dehumidifier.

3. Stop when the water tank is full- Dehumidifier will automatically turn off when the tank is full and the full tank indicator will turn on and sound 10 Seconds to remind you to empty the water tank. Please empty the water tank and reinstall the water tank, unit will run previous setting. If the full indicator keep warning when the tank is empty. Please make sure that the machine is placed smoothly or contact us for technical support. Please check whether the water tank is installed and whether the induction magnet of the water tank is still there.

4. Timing Setting-The dehumidifier can be turned on and off regularly. Start the machine regularly: Press the "TIMER" button after the machine is plugged in to set when the machine will start. Timing shutdown: When the machine is plugged in, press the power-on button and then press the "TIMER" button to set when the machine will shut down.

If you encounter problems, please contact our customer service. We will serve you.

[Email:support@glowellshop.com](mailto:support@glowellshop.com)

<http://www.glowellshop.com>

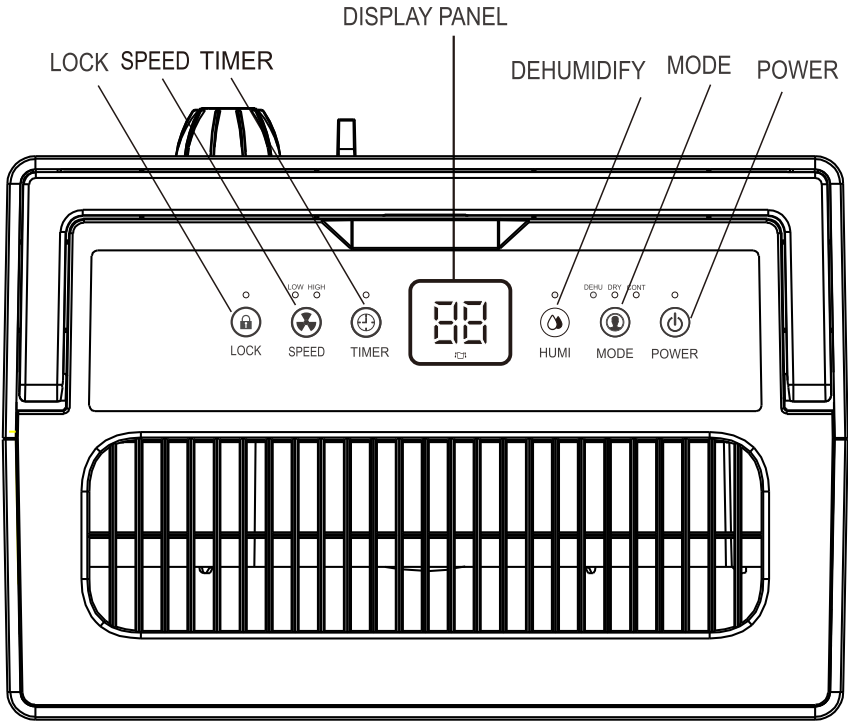

■ Key Description



LOCK KEY

For activation and deactivation of the child lock function.



HUMI KEY

For setting the humidity level.



SPEED KEY

To switch the fan speeds.



MODE KEY

To choose the working mode.



TIMER KEY

To set the time on the device, the setting range is 1~24h.



POWER BUTTON

To turn the machine on/off.

Note:

Allow Standing Time Before Use: After unpacking the dehumidifier, leave it standing upright for 24 hours before plugging it in. This protects the internal components and ensures optimal performance.

Placement and Clearance: Place the dehumidifier on a flat, stable surface, ensuring at least 8 inches of clearance around the unit for proper airflow.

Don't Block the Vents: When positioning the dehumidifier, please ensure it is not placed too close to walls or other objects, as this could obstruct the air vents.

Compressor Start Delay: To protect the compressor and extend its service life, the unit will start operating 3 minutes after being turned on.

Close Doors and Windows: To maximize performance, keep doors and windows closed during operation to prevent additional moisture from entering the space.

Heat Emission During Operation: Dehumidifiers emit heat while in use, which is a normal part of the moisture absorption process.

Avoid Direct Sunlight or Heat Sources: Do not position the unit near heat sources or in direct sunlight, as this can affect its efficiency.

Filter Maintenance for Pet Owners: If you have pets, clean the filter more frequently to prevent pet hair and dander from clogging the unit, which can reduce efficiency.

Ensure Proper Drainage Slope: When using a drainage hose, position it at a downward angle to avoid back flow and allow smooth water removal.

BEFORE FIRST USE:

Please leave the dehumidifier sitting outside the box for **24 HOURS** before plugging it in.

The dehumidifiers may have been tilted or placed upside down during shipping. Leave The dehumidifier sits for 24 hours so the oil in the compressor can settle from the move, Not doing so can affect the performance or lifespan of the dehumidifier.

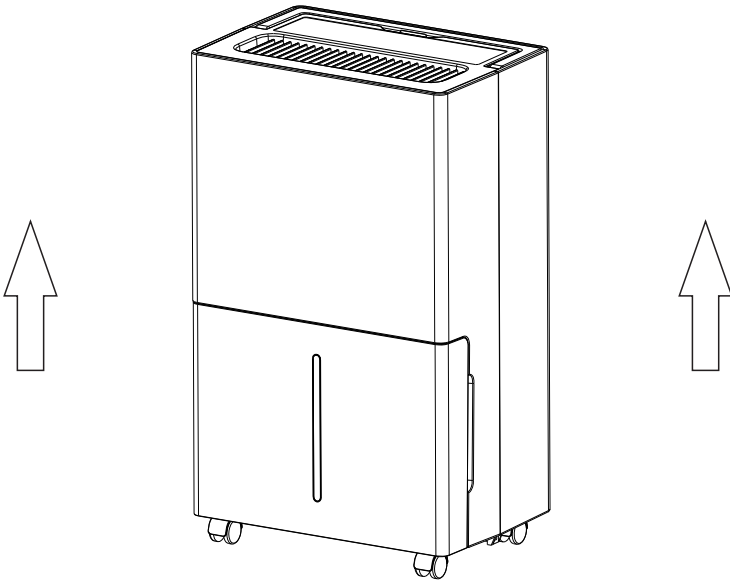

NOTE:

To continuously improve its products, Glowells reserves the right to modify this information without prior notification. For any questions during assembly, please check the instructions on the product page for reference. Or contact our customer service with any questions, comments, or concerns, We are online 24H for you. Thank you for using Glowells products in your home!

Made in China

Welcome

Thanks for choosing Glowells dehumidifier!

Glowells is dedicated to keeping people healthy, comfortable and more enjoyable by offering quality appliances ranging from dehumidifiers to ice makers, and more. From breathing easier in your office to upgrading your kitchen appliances, we hope Glowells could help you every step of the way.

**READ THIS MANUAL INSTRUCTION CAREFULLY BEFORE USING THE UNIT.
PLEASE KEEP THIS FOR FUTURE REFERENCE.**

Glowells PD12A home dehumidifier reducing humidity to comfortable levels in a short period of time. This dehumidifier has a sturdy housing to withstand harsh environments, is safe and easy to use, guarantees long-term use and easy maintenance, plus we use a copper tube condenser and high quality and accurate sensors, it will be more effective and last longer.

Before plugging in your new dehumidifier, we suggest that you read this user manual as it contains important safety information, operation instructions, troubleshooting, maintenance tips, and warranty information to ensure the reliability and longevity of your dehumidifier.

We're always just an email away

To access customer support, please email to support@glowells.shop.com with your purchase order.

Thank you again!

Email: support@glowellsshop.com

http://www.glowellshop.com

Table of Contents

Warning For Using R290 Refrigerant.....	1
Precautions for Use	14
Parts Description	15
Control Panel.....	16
Operation Instructions.....	18
Cleaning and Maintenance.....	25
Fault Phenomenon.....	25
Limited Warranty.....	27

Statement

The graphics and functions provided in this manual maybe not the same as the actual product. The model shown in this manual is only for reference. Please install and operate the machine according to the actual situations.

The company reserves the right to interpret relevant terms.

01 WARNING FOR R290

■ **WARNING for Using R290 Refrigerant**

Transportation, marking and storage for units that employ flammable refrigerants

1.General

The following information is provided for units that employ FLAMMABLE REFRIGERANTS.

2.Transport of equipment containing flammable refrigerants

Attention is drawn to the fact that additional transportation regulations may exist with respect to equipment containing flammable gas. The maximum number of pieces of equipment or the configuration of the equipment permitted to be transported together will be determined by the applicable transport regulations.

3.Marking of equipment using signs

Signs for similar appliances used in a work area are generally addressed by local regulations and give the minimum requirements for the provision of safety and/or health signs for a work location.

All required signs are to be maintained and employers should ensure that employees receive suitable and sufficient instruction and training on the meaning of appropriate safety signs and the actions that need to be taken in connection with these signs.

The effectiveness of signs should not be diminished by too many signs being placed together.

Any pictograms used should be as simple as possible and contain only essential details.

4.Disposal of equipment using flammable refrigerants

Refer to national regulations.

5.Storage of equipment/appliances

The storage of the appliance should be in accordance with the applicable regulations or instructions, whichever is more stringent.

6.Storage of packed (unsold) equipment

Storage package protection should be constructed in such a way that mechanical damage to the equipment inside the package will not cause a leak of the REFRIGERANT CHARGE.

The maximum number of pieces of equipment permitted to be stored together will be determined by local regulations.

Requirements for operation, service and installation manuals of appliances using flammable refrigerants

Warning

Do not use means to accelerate the defrosting process or to clean, other than those recommended by the manufacturer.

The appliance shall be stored in a room without continuously operating ignition sources for example:

open flames, an operating gas appliance or an operating electric heater.

Do not pierce or burn.

Be aware that refrigerants may not contain an odour.



Appliance filled with flammable mag as R290.

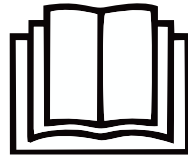

Before use the appliance, read the owner's manual first.

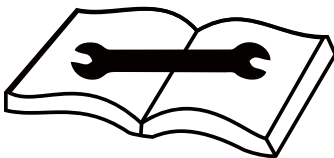

Before repair the appliance, read the service manual first.

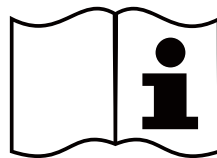

Before install the appliance, read the installation mnual first.

Qualification of workers

The manual shall contain specific information about the required qualification of the working personnel for maintenance, service and repair operations. Every working procedure that affects safety means shall only be carried out by competent persons. Examples for such working procedures are:

- breaking into the refrigerating circuit;
- opening of sealed components;
- opening of ventilated enclosures.

Competence of service personnel

1.General

Information of procedures additional to usual information for refrigerating appliance installation, repair, maintenance and decommission procedures is required when an appliance with FLAMMABLE REFRIGERANT is affected.

The training of these procedures is carried out by national training organisations or manufacturers that are accredited to teach the relevant national competency standards that may be set in legislation.

The achieved competence should be documented by a certificate.

2.Information and training

2.1)The training should include the substance of the following:

2.2)Information about the explosion potential of FLAMMABLE REFRIGERANTS to show that flammables may be dangerous when handled without care.

2.3)Information about POTENTIAL IGNITION SOURCES, especially those that are not obvious, such as lighters, light switches, vacuum cleaners, electric heaters.

2.4) Information about the different safety concepts:

Unventilated-Safety of the appliance does not depend on ventilation of the housing. Switching off the appliance or opening of the housing has no significant effect on the safety. Nevertheless, it is possible that leaking refrigerant may accumulate inside the enclosure and flammable atmosphere will be released when the enclosure is opened.

Ventilated enclosure-Safety of the appliance depends on ventilation of the housing. Switching off the appliance or opening of the enclosure has a significant effect on the safety. Care should be taken to ensure sufficient ventilation before.

Ventilated room -Safety of the appliance depends on the ventilation of the room. Switching off the appliance or opening of the housing has no significant effect on the safety. The ventilation of the room shall not be switched off during repair procedures.

2.5) Information about refrigerant detectors:

- Principle of function, including influences on the operation.
- Procedures, how to repair, check or replace a refrigerant detector or parts of it in a safe way.
- Procedures, how to disable a refrigerant detector in case of repair work on the refrigerant carrying parts.

2.6) Information about the concept of sealed components and sealed enclosures according to IEC60079-15:2010.

2.7) Information about the correct working procedures:

a) Commissioning

- Ensure that the floor area is sufficient for the REFRIGERANT CHARGE or that the ventilation duct is assembled in a correct manner.
- Connect the pipes and carry out a leak test before charging with refrigerant.
- Check safety equipment before putting into service.

b) Maintenance

- Portable equipment shall be repaired outside or in a workshop specially equipped for servicing units with FLAMMABLE REFRIGERANTS.
- Ensure sufficient ventilation at the repair place.
- Be aware that malfunction of the equipment may be caused by refrigerant loss and a refrigerant leak is possible.
- Discharge capacitors in a way that won't cause any spark. The standard procedure to short circuit the capacitor terminals usually creates sparks.
- Reassemble sealed enclosures accurately. If seals are worn, replace them.
- Check safety equipment before putting into service.

c) Repair

- Portable equipment shall be repaired outside or in a workshop specially equipped for servicing units with FLAMMABLE REFRIGERANTS.
- Ensure sufficient ventilation at the repair place.
- Be aware that malfunction of the equipment may be caused by refrigerant loss and a refrigerant leak is possible.
- Discharge capacitors in a way that won't cause any spark.
- When brazing is required, the following procedures shall be carried out in the following order:
 - Safely remove the refrigerant following local and national regulations. If the recovery is not required by national regulations, drain the refrigerant to the outside. Take care that the drained refrigerant will not cause any danger. In doubt, one person should guard the outlet. Take special care that drained refrigerant will not float back into the building;
 - Purge the refrigerant circuit with oxygen free nitrogen;
 - Evacuate the refrigerant circuit;
 - Purge the refrigerant circuit with nitrogen for 5 min (not required for A2L refrigerants).

- Evacuate again (not required for A2L refrigerants).
- Remove parts to be replaced by cutting or brazing.
- Purge the braze point with nitrogen during the brazing procedure required for repair.
- Carry out a leak test before charging with refrigerant.
- Reassemble sealed enclosures accurately. If seals are worn, replace them.
- Check safety equipment before putting into service.

d) Decommissioning

- If the safety is affected when the equipment is putted out of service, the REFRIGERANT CHARGE shall be removed before decommissioning.
- Ensure sufficient ventilation at the equipment location.
- Be aware that malfunction of the equipment may be caused by refrigerant loss and a refrigerant leak is possible.
- Discharge capacitors in a way that won't cause any spark.
- Remove the refrigerant. If the recovery is not required by national regulations, drain the refrigerant to the outside. Take care that the drained refrigerant will not cause any danger. In doubt, one person should guard the outlet. Take special care that drained refrigerant will not float back into the building.
- When FLAMMABLE REFRIGERANTS except A2L REFRIGERANTS are used.
 - Evacuate the refrigerant circuit.
 - Purge the refrigerant circuit with nitrogen for 5 min.
 - Evacuate again.
 - Fill with nitrogen up to atmospheric pressure.
 - Put a label on the equipment that the refrigerant is removed.

e) Disposal

- Ensure sufficient ventilation at the working place.
- Remove the refrigerant. If the recovery is not required by national regulations, drain the refrigerant to the outside. Take care that the drained refrigerant will not cause any danger. In doubt, one person should guard the outlet. Take special care that drained refrigerant will not float back into the building.
- When flammable refrigerants are used,
 - evacuate the refrigerant circuit.
 - purge the refrigerant circuit with oxygen free nitrogen.
 - evacuate again. (not required for A2L refrigerants); and
 - cut out the compressor and drain the oil.

Information on servicing

1.General

The manual shall contain specific information for service personnel according.

2.Checks to the area

Prior to beginning work on systems containing FLAMMABLE REFRIGERANTS, safety checks are necessary to ensure that the risk of ignition is minimised. For repair to the REFRIGERATING SYSTEM.

3.Work procedure

Work shall be undertaken under a controlled procedure so as to minimise the risk of a flammable gas or vapour being present while the work is being performed.

4.General work area

All maintenance staff and others working in the local area shall be instructed on the nature of work being carried out. Work in confined spaces shall be avoided.

5. Checking for presence of refrigerant

The area shall be checked with an appropriate refrigerant detector prior to and during work, to ensure the technician is aware of potentially toxic or flammable atmospheres. Ensure that the leak detection equipment being used is suitable for use with all applicable refrigerants, i. e. non-sparking, adequately sealed or intrinsically safe.

6. Presence of fire extinguisher

If any hot work is to be conducted on the refrigerating equipment or any associated parts, appropriate fire extinguishing equipment shall be available to hand. Have a dry powder or CO₂ fire extinguisher adjacent to the charging area.

7. No ignition sources

No person carrying out work in relation to a REFRIGERATING SYSTEM which involves exposing any pipe work shall use any sources of ignition in such a manner that it may lead to the risk of fire or explosion. All possible ignition sources, including cigarette smoking, should be kept sufficiently far away from the site of installation, repairing, removing and disposal, during which refrigerant can possibly be released to the surrounding space. Prior to work taking place, the area around the equipment is to be surveyed to make sure that there are no flammable hazards or ignition risks. "No Smoking" signs shall be displayed.

8. Ventilated area

Ensure that the area is in the open or that it is adequately ventilated before breaking into the system or conducting any hot work. A degree of ventilation shall continue during the period that the work is carried out. The ventilation should safely disperse any released refrigerant and preferably expel it externally into the atmosphere.

9. Checks to the refrigerating equipment

Where electrical components are being changed, they shall be fit for the purpose and to the correct specification. At all times the manufacturer's maintenance and service guidelines shall be followed. If in doubt, consult the manufacturer's technical department for assistance.

The following checks shall be applied to installations using FLAMMABLE REFRIGERANTS:

- the actual REFRIGERANT CHARGE is in accordance with the room size within which the refrigerant containing parts are installed;
- the ventilation machinery and outlets are operating adequately and are not obstructed;
- if an indirect refrigerating circuit is being used, the secondary circuit shall be checked for the presence of refrigerant;
- marking to the equipment continues to be visible and legible. Markings and signs that are illegible shall be corrected;
- refrigerating pipe or components are installed in a position where they are unlikely to be exposed to any substance which may corrode refrigerant containing components, unless the components are constructed of materials which are inherently resistant to being corroded or are suitably protected against being so corroded.

10.Checks to electrical devices

Repair and maintenance to electrical components shall include initial safety checks and component inspection procedures. If a fault exists that could compromise safety, then no electrical supply shall be connected to the circuit until it is satisfactorily dealt with. If the fault cannot be corrected immediately but it is necessary to continue operation, an adequate temporary solution shall be used. This shall be reported to the owner of the equipment so all parties are advised.

Initial safety checks shall include:

- that capacitors are discharged: this shall be done in a safe manner to avoid possibility of sparking;
- that no live electrical components and wiring are exposed while charging, recovering or purging the system;
- that there is continuity of earth bonding.

11.Repairs to sealed components

Sealed electrical components shall be replaced.

12.Repair to intrinsically safe components

Intrinsically safe components must be replaced.

13.Cabling

Check that cabling will not be subject to wear, corrosion, excessive pressure, vibration, sharp edges or any other adverse environmental effects. The check shall also take into account the effects of aging or continual vibration from sources such as compressors or fans.

14.Detection of flammable refrigerants

Under no circumstances shall potential sources of ignition be used in the searching for or detection of refrigerant leaks. A halide torch (or any other detector using a naked flame) shall not be used.

The following leak detection methods are deemed acceptable for all refrigerant systems.

Electronic leak detectors may be used to detect refrigerant leaks but, in the case of FLAMMABLE REFRIGERANTS, the sensitivity may not be adequate, or may need re-calibration. (Detection equipment shall be calibrated in a refrigerant-free area.) Ensure that the detector is not a potential source of ignition and is suitable for the refrigerant used. Leak detection equipment shall be set at a percentage of the LFL of the refrigerant and shall be calibrated to the refrigerant employed, and the appropriate percentage of gas(25 % maximum) is confirmed.

Leak detection fluids are also suitable for use with most refrigerants but the use of detergents containing chlorine shall be avoided as the chlorine may react with the refrigerant and corrode the copper pipe-work.

NOTE Examples of leak detection fluids are:

- bubble method.
- fluorescent method agents.

If a leak is suspected, all naked flames shall be removed/extinguished.

If a leakage of refrigerant is found which requires brazing, all of the refrigerant shall be recovered from the system, or isolated (by means of shut off valves) in a part of the system remote from the leak.

15. Removal and evacuation

When breaking into the refrigerant circuit to make repairs - or for any other purpose - conventional procedures shall be used. However, for flammable refrigerants it is important that best practice be followed, since flammability is a consideration.

The following procedure shall be adhered to:

- safely remove refrigerant following local and national regulations;
- evacuate;
- purge the circuit with inert gas (optional for A2L);
- evacuate (optional for A2L);
- continuously flush or purge with inert gas when using flame to open circuit ; and
- open the circuit.

The refrigerant charge shall be recovered into the correct recovery cylinders if venting is not allowed by local and national codes. For appliances containing flammable refrigerants, the system shall be purged with oxygen-free nitrogen to render the appliance safe for flammable refrigerants. This process might need to be repeated several times. Compressed air or oxygen shall not be used for purging refrigerant systems.

For appliances containing flammable refrigerants, refrigerant purging shall be achieved by breaking the vacuum in the system with oxygen-free nitrogen and continuing to fill until the working pressure is achieved, then venting to atmosphere, and finally pulling down to a vacuum (optional for A2L). This process shall be repeated until no refrigerant is within the system (optional for A2L). When the final oxygen-free nitrogen charge is used, the system shall be vented down to atmospheric pressure to enable work to take place.

The outlet for the vacuum pump shall not be close to any potential ignition sources, and ventilation shall be available.

16. Charging procedures

In addition to conventional charging procedures, the following requirements shall be followed.

- Ensure that contamination of different refrigerants does not occur when using charging equipment. Hoses or lines shall be as short as possible to minimise the amount of refrigerant contained in them.
- Cylinders shall be kept in an appropriate position according to the instructions.
- Ensure that the REFRIGERATING SYSTEM is earthed prior to charging the system with refrigerant.
- Label the system when charging is complete (if not already).
- Extreme care shall be taken not to overfill the REFRIGERATING SYSTEM.

Prior to recharging the system, it shall be pressure-tested with the appropriate purging gas. The system shall be leak-tested on completion of charging but prior to commissioning. A follow up leak test shall be carried out prior to leaving the site.

17.Decommissioning

Before carrying out this procedure, it is essential that the technician is completely familiar with the equipment and all its detail. It is recommended good practice that all refrigerants are recovered safely. Prior to the task being carried out, an oil and refrigerant sample shall be taken in case analysis is required prior to re-use of recovered refrigerant. It is essential that electrical power is available before the task is commenced.

- a) Become familiar with the equipment and its operation.
- b) Isolate system electrically.
- c) Before attempting the procedure, ensure that:
 - mechanical handling equipment is available, if required, for handling refrigerant cylinders;
 - all personal protective equipment is available and being used correctly;
 - the recovery process is supervised at all times by a competent person;
 - recovery equipment and cylinders conform to the appropriate standards.
- d) Pump down refrigerant system, if possible.
- e) If a vacuum is not possible, make a manifold so that refrigerant can be removed from various parts of the system.
- f) Make sure that cylinder is situated on the scales before recovery takes place.
- g) Start the recovery machine and operate in accordance with instructions.
- h) Do not overfill cylinders (no more than 80 % volume liquid charge).
- l) Do not exceed the maximum working pressure of the cylinder, even temporarily.
- j) When the cylinders have been filled correctly and the process completed, make sure that the cylinders and the equipment are removed from site promptly and all isolation valves on the equipment are closed off.
- k) Recovered refrigerant shall not be charged into another REFRIGERATING SYSTEM unless it has been cleaned and checked.

18.Labelling

Equipment shall be labelled stating that it has been de-commissioned and emptied of refrigerant. The label shall be dated and signed. For appliances containing FLAMMABLE REFRIGERANTS, ensure that there are labels on the equipment stating the equipment contains FLAMMABLE REFRIGERANT.

19.Recovery

When removing refrigerant from a system, either for servicing or decommissioning, it is recommended good practice that all refrigerants are removed safely.

When transferring refrigerant into cylinders, ensure that only appropriate refrigerant recovery cylinders are employed. Ensure that the correct number of cylinders for holding the total system charge is available. All cylinders to be used are designated for the recovered refrigerant and labelled for that refrigerant (i. e. special cylinders for the recovery of refrigerant). Cylinders shall be complete with pressure-relief valve and associated shut-off valves in good working order. Empty recovery cylinders are evacuated and, if possible, cooled before recovery occurs.

The recovery equipment shall be in good working order with a set of instructions concerning the equipment that is at hand and shall be suitable for the recovery of the flammable refrigerant. If in doubt, the manufacturer should be consulted. In addition, a set of calibrated weighing scales shall be available and in good working order. Hoses shall be complete with leak-free disconnect couplings and in good condition.

The recovered refrigerant shall be processed according to local legislation in the correct recovery cylinder, and the relevant waste transfer note arranged. Do not mix refrigerants in recovery units and especially not in cylinders.

If compressors or compressor oils are to be removed, ensure that they have been evacuated to an acceptable level to make certain that flammable refrigerant does not remain within the lubricant. The compressor body shall not be heated by an open flame or other ignition sources to accelerate this process. When oil is drained from a system, it shall be carried out safely.

Precautions for Use

Safety notes:

For your safety, please read this manual carefully and keep it for future reference. This product is for home use only. Please install and use the product according to the operations in this manual.

- Before cleaning the dehumidifier, please turn off the machine and unplug it from the power source.
- Please do not place the machine near heat or flammable goods.
- Do not put any sticks or your fingers into the air inlet or outlet.
- Please always place the machine on a flat ground, rather than uneven or slopping ones.
- Do not spray water, insecticides or flammable liquids on the machine.
- Please do not place the machine in a confined or narrow space.
- If the power cord is damaged, please contact a technician approved by the company to replace it.
- In Dry Mode, please keep the clothes at least 15.7 inches away from the air outlet to prevent the water entering the machine to cause damages.
- Please make sure the machine power wiring is installed in accordance with national wiring rules. The power cord should be connected to a reliable external naught wire.
- The fixed wiring connected to the machine must be equipped with an all-pole disconnect device (air switch) with a contact distance of at least 0.118 inch.
- The specification of the fuse: 3.15A.
- Please use this dehumidifier in an environment with the temperature range between 41°F/5°C and 95°F/35°C.
- When using the dehumidifier, please keep other surrounding objects at least 7.9 inches/20cm away from the machine. As shown in the picture:

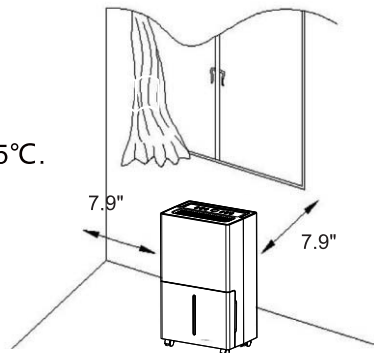

Parts Description

Front

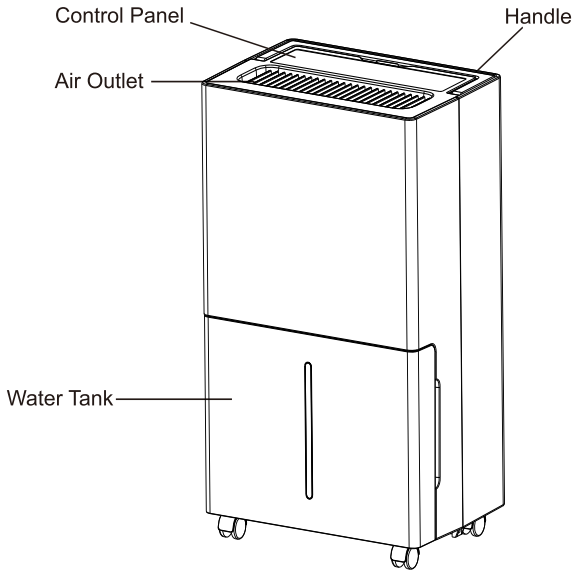

Back

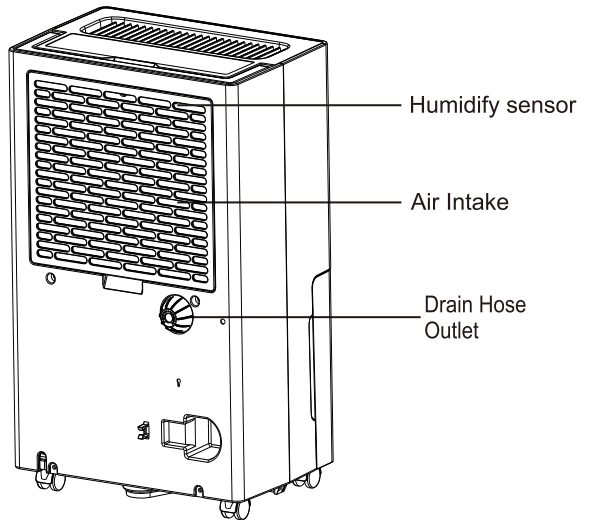

Control Panel

1. Control Panel

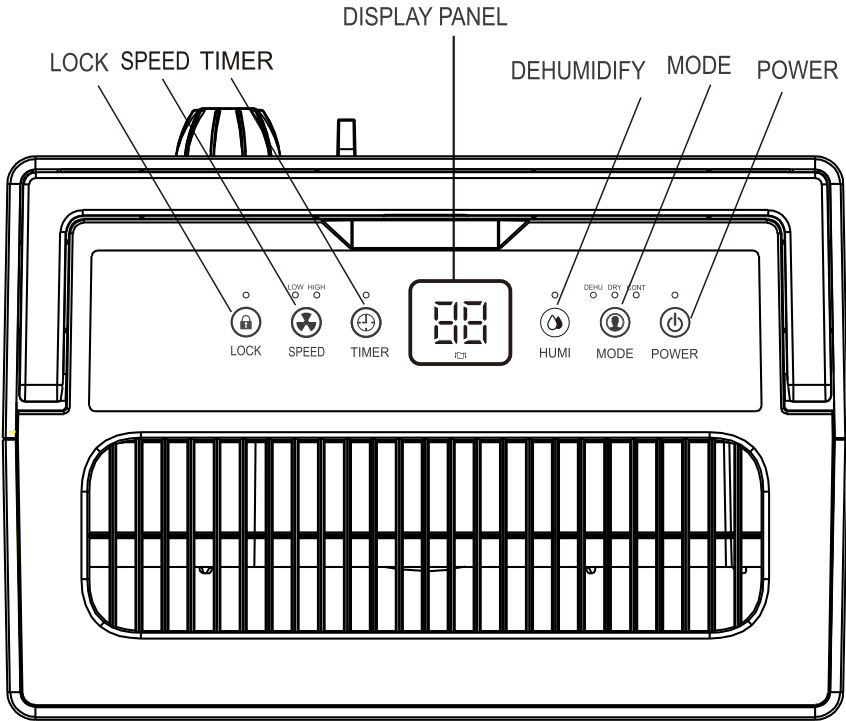

■ Key Description



LOCK KEY

For activation and deactivation of the child lock function.



HUMI KEY

For setting the humidity level.



SPEED KEY

To switch the fan speeds.



MODE KEY

To choose the working mode.



TIMER KEY

To set the time on the device, the setting range is 1~24h.



POWER BUTTON

To turn the machine on/off.

Note:

Allow Standing Time Before Use: After unpacking the dehumidifier, leave it standing upright for 24 hours before plugging it in. This protects the internal components and ensures optimal performance.

Placement and Clearance: Place the dehumidifier on a flat, stable surface, ensuring at least 8 inches of clearance around the unit for proper airflow.

Don't Block the Vents: When positioning the dehumidifier, please ensure it is not placed too close to walls or other objects, as this could obstruct the air vents.

Compressor Start Delay: To protect the compressor and extend its service life, the unit will start operating 3 minutes after being turned on.

Close Doors and Windows: To maximize performance, keep doors and windows closed during operation to prevent additional moisture from entering the space.

Heat Emission During Operation: Dehumidifiers emit heat while in use, which is a normal part of the moisture absorption process.

Avoid Direct Sunlight or Heat Sources: Do not position the unit near heat sources or in direct sunlight, as this can affect its efficiency.

Filter Maintenance for Pet Owners: If you have pets, clean the filter more frequently to prevent pet hair and dander from clogging the unit, which can reduce efficiency.

Ensure Proper Drainage Slope: When using a drainage hose, position it at a downward angle to avoid back flow and allow smooth water removal.

2.Setting

Mode Setting

There are DEHU Mode, DRY Mode, CONT Mode.

After the machine is turned on, press the "MODE" button to switch the working modes. Each time pressing the button, the machine will cycle through the DEHU mode, the Clothes-Dryer mode, and the Continuous Dehumidifying mode.

Notices:

In the DEHU Mode: Both the humidity and fan speed are settable.

In the DRY Mode: Both the humidity and fan speed are not settable.

In the CONT Mode: The fan speed is settable, while the humidity is not settable.

Humidity Setting:

The humidity level can be set within the range of 30% RH to 80% RH in 5% increments.

-When the machine starts working, it will first automatically detect and show the room humidity. In the dehumidification mode (not settable under the other modes), press the "HUMIDITY" button to change the humidity selection, each time in 5% increments. The number indicator "88" will keep flashing and show the set humidity. Once you have settled the humidity you want, please stop operating and wait for 5 seconds, the number indicator "88" will stop flashing and turn to show the actual room humidity instead.

-When the humidity level falls below the set humidity, the dehumidifier will automatically stop working, while the humidity level exceeds the set humidity, it will automatically start working again.



-When the humidity level is set at 30% RH, the dehumidifier will turn to work in the continuous dehumidifying mode.

Timer Setting:

The time setting is used to set a time for the machine to automatically turn on or turn off.

1. When the machine is turned on, the time setting is used for auto turn-off; When the machine is turned off, the time setting is used for auto turn-on.
2. Press the "TIMER" button to select the timer, each time in 1-hour increments. You can set the timer up to 24 hours. It will start to do the countdown when the setting is finished.
3. If the time is set at "00", this is called the invalid time which means the time setting is invalid. Once the time setting is succeeded, the light "⌚" will light up, and the led screen will keep showing the setting time for seconds, then turn back to show the current room humidity.

Lock Setting

When the machine is turned on, press and hold the LOCK button "  " for 3 seconds, the control panel will be locked together with the other function buttons. To unlock the control panel, press and hold the LOCK button "  " again for 3 seconds.

Speed Button

The speed button is used to control the fan's speed, it can be switched to the high-speed mode or low-speed mode.



*Notice:

The high-speed mode will gain the moisture removal effect, while the low-speed mode will be much quieter, please choose your preferred speed mode accordingly.

Memory Function

If a power interruption occurs when the machine is in the turned-on state and working normally, it will restore the turned-on state directly and remain the previous parameters settings after the power is recovered.

Overflow Protection

When the water in the water tank reaches full, the machine will turn off automatically. The indicator light "  " will start flashing, and the buzzer will alarm for seconds. After emptying the water from the water tank, the indicator light "  " will turn off, and the machine will start to work again.

*Notice:

Please make sure the machine is placed on a flat surface, or it may also cause the alarm and protection when the water is not full.









Auto Defrost Function

When the machine is running at a very low temperature, the system will automatically determine whether there is a presence of frost. If the machine determines there is a presence of frost, it will start to defrost automatically.

Defrost Action

The fan will run at the high-speed mode while the compressor will stop working. Defrost Status Display In the defrosting status, the power button "  " will keep flashing.

3.Display Status Description

- ▶ After the machine is settled up an electric circuit, the "POWER" button " " will light on which means the machine is powered on and stays at the Standby (Turned- off) status.
- ▶ Timer indicator " ": If the timer is set up properly, the indicator will turn on, when the timer is not set up properly the indicator light will turn off.
- ▶ The lighting button indicators - the mini round lights: When using the light function the indicator will turn on, and turn off if the function is not used.
- ▶ High-speed indicator " " : If you set the machine to high-speed fan mode, the indicator will turn on.
- ▶ Low-speed indicator " " : If you set the machine to low-speed fan mode, the indicator will turn on.
- ▶ Dehumidifying mode indicator "o": When the dehumidifying mode is selected this indicator will be on. otherwise it will be off.
- ▶ Clothes-Dryer indicator " " : When the Clothes-Dryer mode is selected, the indicator will turn on, otherwise it will be off.
- ▶ Continuous Dehumidifying mode indicator " " : When the Continuous Dehumidifying mode is selected, the indicator will turn on, otherwise it will be off.
- ▶ Water full light indicator " " : When the water tank is full of water, the indicator will start flashing.
- ▶ When the machine is working properly, the data " " on the display panel will be the humidity value.
- ▶ The dual 8 lights will flash when the humidity reaches the set value

4.Instructions for Drying Clothes

The dehumidifier can be used for drying clothes in rainy weather.

Step 1.

Hang the washed clothes in a small space such as a cloakroom, bathroom, or storage room.

Notice: Keep the unit away from the water drip from the washed clothes.

Step 2.

Open the dehumidifier and set the humidity level at 30% RH. It is suggested to let the air outlet of the dehumidifier blow air to the clothes directly.

1. The drying effect will vary from the thickness of clothes, the number of clothes, and the size of the drying room. Theoretically, the effect will be better when clothes are few, thin and the room is small.
2. The drying process would take 3 - 8 hours, thus, setting the machine to the continuous drainage mode is more suggested when drying clothes.

5. Faults and Solutions

Problems	Analysis of Causes	Solutions
Humidity always shows "25% RH" but there is a big difference from the actual humidity.	Does the humidity sensor fail?	Set the humidity to 30% RH and check if the dehumidifier can work normally. If it does, the machine is in a good condition.
		Repair or replace the humidity sensor.
Humidity always shows "99% RH" but there is a big difference from the actual humidity.	Is there some water on the surface of the humidity sensor?	The dehumidifier can work normally. The moisture removal effect is not affected.
		Please keep the machine working for a while to remove the water on the humidity sensor surface. The machine will work normally when the water is removed.
		Repair or replace the humidity sensor.

If the malfunctions still exist, please don't hesitate to contact glowells Customer Service at support@glowells.shop.com for help.

Notice:

1. Do not block or block the air outlet, Or place something above the air outlet, and the air inlet should not be too close to the wall. It is recommended to be 11.81 inches away from the wall.
2. Do not unplug the power cord directly to turn off the machine.

6.Empty the Tank or Bucket

There are two ways to remove collected water.

Use the Bucket

When the water tank is already full, the Full Tank Alert indicator will light up,the dehumidifier will automatically shut down until the tank has been emptied and placed back to the unit.

Ways to Empty the Water Tank

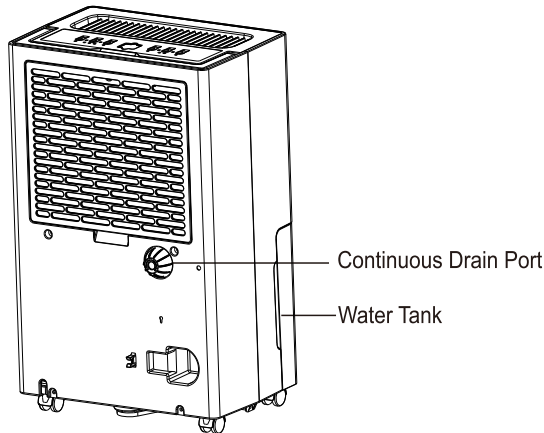
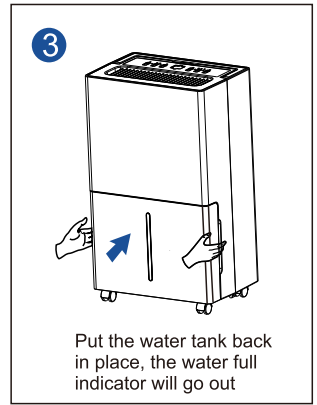
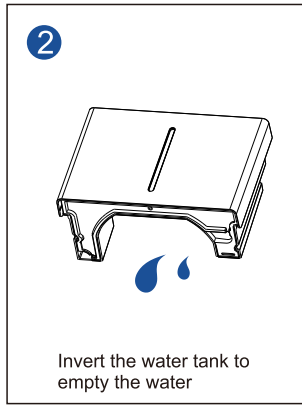
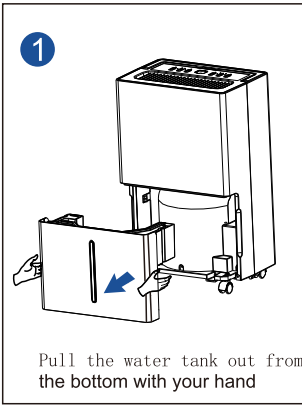

Note:

- Do not remove the float from the water tank. If the float in the water tank is removed, the sensor may not be able to determine the water level stored in the tank properly that may lead to water overflow leak from the water tank.
- If the water tank is dirty, just use cold water or warm water to clean it. Do not use detergent, steel wool, chemically treated dust cloth, gasoline, benzene, thinner or other solvents. Otherwise, it may damage the water tank and cause it to leak.
- When placing back the water tank, use your hands to press the tank back in its place. If the water tank is not placed properly, sensors or protections from water overflow may not operate as expected.

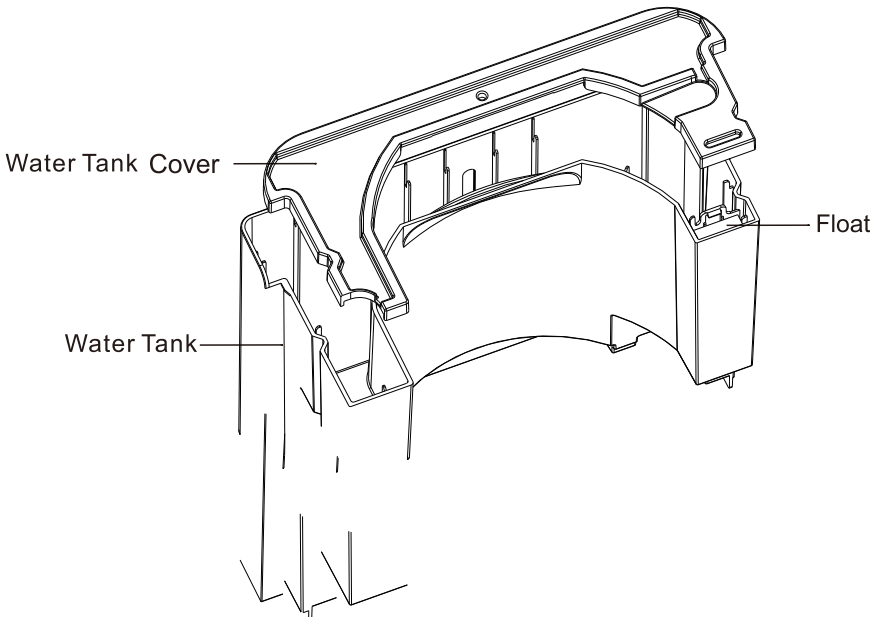

7. Continuous Drainage

Remove the power supply and remove the water tank. Open the drain cover, remove the rubber plug, insert the water pipe into the continuous drain, then push the water tank back into the body, connect the power supply, start the operation, and ensure that the water tank is installed in place, you can carry out the continuous drainage function.

Do not bend the drain hose. (Note: The diameter of the continuous drain port is 5/8 inch.)

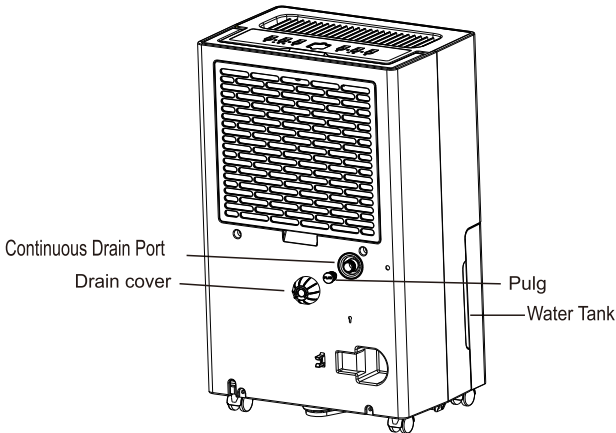
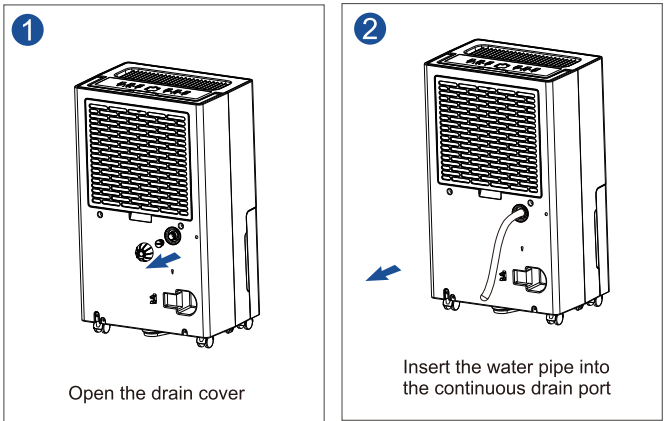

Cleaning and Maintenance

⚠ WARNING:

Turn the dehumidifier off and remove the plug from the power source before cleaning

A- Cleaning the dehumidifier body

Please use only a soft and a bit wet textile or cloth to clean it.

B- Cleaning filter

- 1 Pull out the filter.
- 2 Clean the filter: use a vacuum cleaner to gently remove the dust from the surface of the filter. if the filter is very dirty, wipe it with warm water and a mild detergent and dry it completely.
- 3 Slowly insert the filter back into the fuselage.

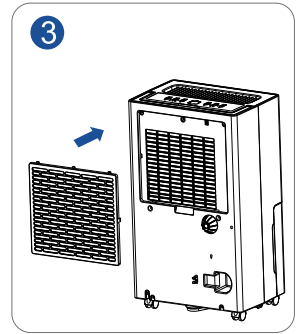
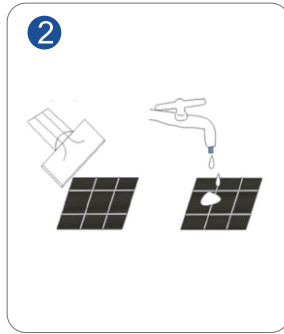
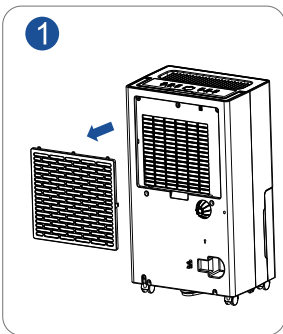

C-Dehumidifier Storage

When you want to store the dehumidifier because you don't use it for a long time.

Please pay attention to the following steps:

1. Empty the water in the water tank.
2. Roll up the power cord and tie it up.
3. Clean the filter.
4. Place the machine in a cool and dry environment.

■ Fault Phenomenon

Fault Phenomenon	Cause Analysis	Approach
The machine is not running.	Is the power cord connected properly?	Connect the plug into the socket.
	Is the water tank in the proper position?	Drain the water from the tank and put it back in the correct position on the body.
	Is the room temperature above 95°F (35°C) or below 41°F(5°C)?	Because this product is not suitable for extreme environments, the machine will automatically protect and turn off, which is a normal phenomenon.
	Is the room temperature between 68°F (20°C)above 95°F(35°C)?	The machine will cool automatically, which is normal.
Poor dehumidification efficiency	Poor air flow?	There should be about 7.9 inches(20cm) of space around the product.
	Is the ambient humidity too low?	A normal phenomenon.
Loud noise when running	Air intake blocked?	Clean any dirt from the air inlet and outlet of the product.
	Is the machine placed at an angle?	Move the machine to a level surface.
The drain hose was properly connected and Water leakage or the water still drained to the tank.	Connected to the hose without pulling out the gray rubber plug of the water outlet.	Pull out the grey rubber plug of the water outlet before connecting the water pipe (please refer to the schematic diagram of continuous drainage function page in the manual for details)
	The pipe is not connected properly, the other end of the pipe is blocked and the water cannot be discharged properly.	Ensure that both ends of the water pipe are unimpeded after connecting the water pipe. Keeping the water pipe in an inclined state is more conducive to gravity drainage.
The humidity displays "EF."	Is there a fan malfunction?	Check for any objects that may be causing the fan to jam. Repair or replace the fan.
The dehumidifier is started but doesn't work.	The tank is full or not installed properly.	Empty the tank and reinstall it in place.
	The sensor float in the tank got stuck and didn't reposition properly.	Push the float down to the lowest position for the correct float position.
	The dehumidifier is in the defrosting process, it is normal the compressor ceases while defrosting process.	The defrosting process may take 15 to 20 minutes.When the defrosting is complete, the dehumidifier automatically starts to continue the dehumidification process.

Notice:

Please make sure that the air outlet is open before starting the machine, otherwise the machine will overheat. Never stop the machine directly by unplugging the power cord. If the problem persists, please shut down and unplug the power plug, Please contact Glowells to serve support@glowellsshop.com

Limited Warranty

Warranty and Service

If you have an issue with an Glowells product, please contact us at support@glowellshop.com, and we will do our best to resolve it for you.



Support Hours

24 Hours available

*Please have your order number before contacting customer support.

<http://www.glowellshop.com>

Product Certification

The product is approved to leave the factory after passing the inspection.

Production date: see the nameplate or barcode of the fuselage



Glowells

